

Ethernet I/O Modules: ADAM-6000 / 6200 / 6300

Introduction

Advantech's ADAM-6000/6200/6300 Ethernet I/O modules are easily integrated so they can remotely monitor and Cross-site Devices more flexibly.

Feature Highlights

Secure Cloud I/O

Innovative ADAM-6000/6200 Secure Cloud I/O offers device management, OTA updates, security and device monitoring functions in IoT era and help user easily manage widespread assets across diverse applications

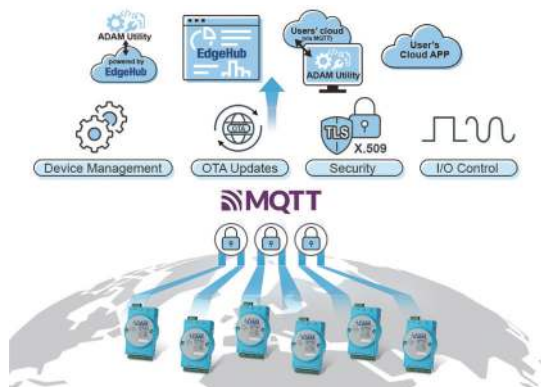

- **Device Management:** UUID, networking setting, I/O channel configuration
- **OTA Updates:** firmware and configuration mass deployment
- **Security:** TLS, X.509 certificate, cipher suites, IP allowlisting, protocol disabled
- **I/O Control:** digital I/O on/off, analog I/O read/write, I/O value periodically updated, alarm notification

Simple and Intuitive Logic Control

ADAM-6000/6200 Peer-to-Peer (P2P) and Graphic Condition Logic (GCL) modules can perform as standalone products for measurement, control, and automation.



Peer-to-Peer (P2P) connection

- Easy channel mapping from different I/O modules without extra programming effort or additional controllers.
- Utilizes Peer-to-Peer modules, just configure settings through Advantech IO Module Utility.

Graphic condition logic (GCL)

- GCL function is built-in ADAM-6000 and ADAM-6200 modules for users to easily set up logic rules in any application.
- User defined logic rules through graphical configuration environment in Advantech IO Module Utility.
- No additional controllers or programming is needed.

Easy Deployment and Robust Communication



Flexible deployment with daisy chain networking and auto-bypass protection

ADAM-6200/6300 series supports daisy chain connectivity that offers flexible cabling and space saving capabilities. With Ethernet auto-bypass function supported to prevent accidental power failures if one of the modules unexpectedly shuts down.

Rich IoT Protocols

The ADAM-6000/6200 series supports multiple protocols for IoT applications: MQTT, SNMP, Restful APIs, and Modbus, which are very flexible and can be easily integrated with Microsoft Azure and customer's Database, Network and SCADA systems.



Cloud

- Support EdgeHub, Azure IoT Hub and any user's cloud.

MQTT

- Actively publish MQTT messages with user defined intervals.
- Shorten downtime with agile sequence of event ("ms" resolution) and alarm notification.
- Privacy assured with the TLS (Transport Layer Security).
- Flexible user defined topic and payload to integrate existing system.
- DI with ms level timestamps involved in channel/all data topic for SoE or more sensitive monitoring applications

SNMP

- Simple way to monitor I/O data on NMS (Network Management System).
- SNMP trap to notify change events.
- Reduces implementation cost with ADAM MIB (Management Information Base) file.

Industrial Grade with Isolation & Wide-operating Temperature

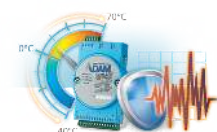

ADAM-6000/6200/6300 series has a rugged design.

- Supports isolation protection to avoid system damage from high-energy noise.
- Supports operating temperatures of between -40 ~70°C and can perform in most harsh environments.

Application Structure

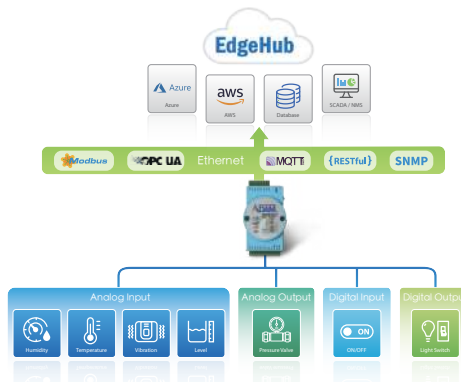

ADAM-6000 / 6200 / 6300 Series Comparison

Series Name	ADAM-6000 Series	ADAM-6200 Series	ADAM-6300 Series
Daisy-chain Connectivity	-	✓	✓
Protocol	MQTT	✓	(By request)
	SNMP	✓	(By request)
	Modbus	✓	✓
	RESTful	✓	(By request)
	OPC UA	-	-
Cloud I/O	✓	✓	(By request)

EdgeHub-enabled Cross-Site Device Management Solution

Effortless Cross-Site Management - Free to Use Now!



More information on website

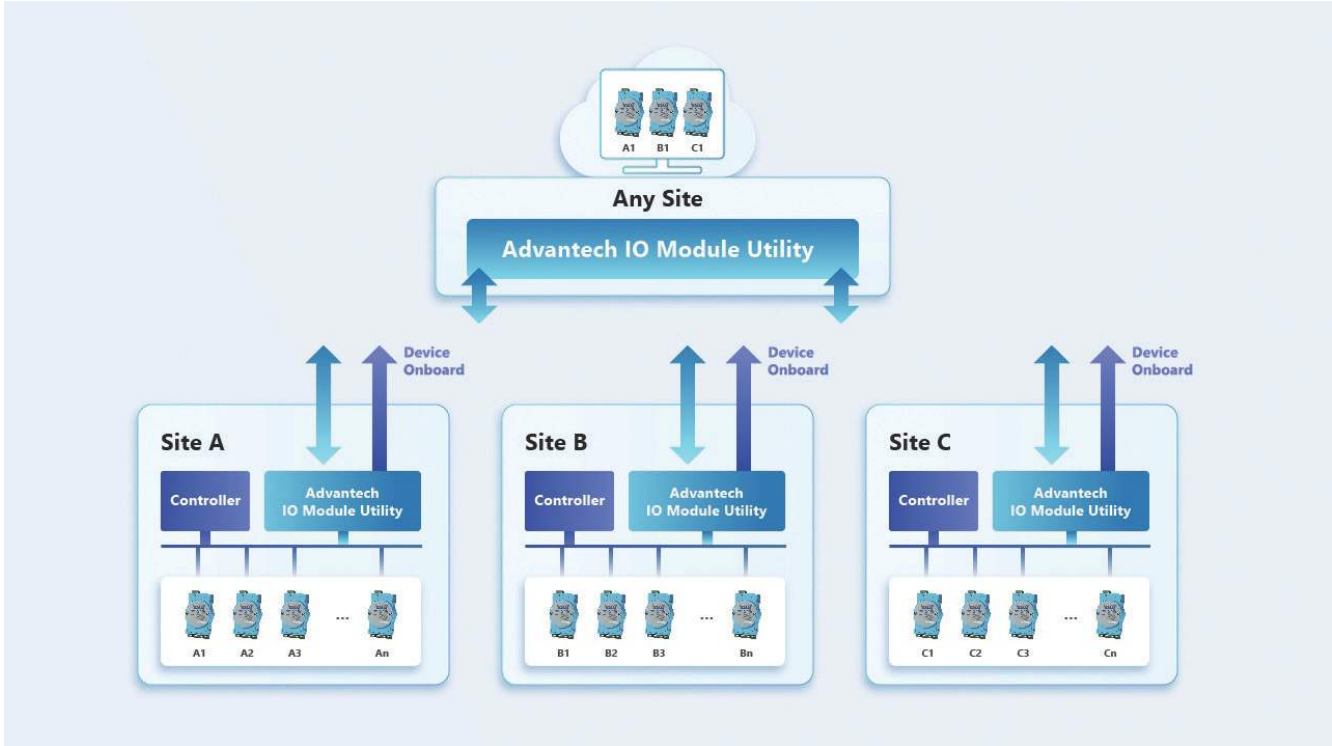

Direct I/O and Centralized Configuration

- EdgeHub enables device management with remote configuration, monitoring and maintenance capabilities for Advantech devices.
- Configure and maintain ADAM devices via Advantech IO Module Utility with built-in EdgeHub and web interface.
- Monitor and control I/O in real-time
- Manage user-defined configuration profiles and apply to devices
- Update device firmware remotely through secure OTA
- Manage multiple devices in groups with batch configuration and monitoring

Configurable Data Logging and Dashboard

- Flexible data logging and visualization with selectable tag configurations and customizable dashboard.
- Configure data logging by selecting I/O tags to store
- Customize web-based dashboard to view real-time and historical data

Multi-Tenant Architecture

- Support multiple organizations with isolated environments and resource management through tenant management.
- Tenant isolation – device, data storage, network traffic, API access
- Hierarchical tenant structures with parent-child relationships for enterprise deployments
- Tenant-specific user management and authentication
- Device connection quota management per tenant

Flexible Event Notification System

- User-defined event settings with real-time notification delivery through multiple communication channels.
- Define event rules based on device I/O tags
- Configure targeted notifications with customizable groups, users, and content
- Distribute alerts through email and other supported channels
- Track event history and acknowledgement status

Enterprise-Grade Access Control

- Secure access management with role-based control (RBAC) and user account
- Define role-based access control with customized permission sets
- Control user access right to devices configurations, monitoring and operations
- Manage user accounts with hierarchical roles and granular permissions

ADAM-6015

ADAM-6017

ADAM-6018+

7-ch Isolated RTD Input Modbus TCP Module
8-ch Isolated Analog Input Modbus TCP Module
with 2-ch DO

8-ch Isolated Thermocouple Input Module

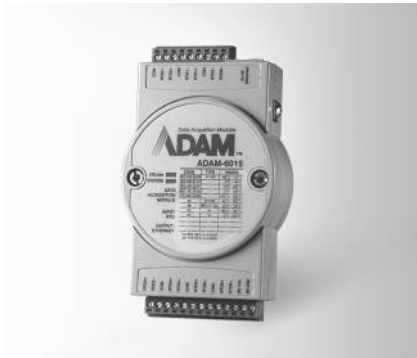

ADAM-6015    



ADAM-6017    



ADAM-6018+    

Specifications

Analog Input

- Channels 7 (differential)
- Input Impedance > 10 MΩ
- Input Connections 2 or 3 wire
- Input Type Pt, Balco and Ni RTD
- RTD Types and Temperature Ranges

Pt 100	-50°C ~ 150°C
	0°C ~ 100°C
	0°C ~ 200°C
	0°C ~ 400°C
	-200°C ~ 200°C
Pt 1000	-40°C ~ 160°C
- Supports both IEC 60751 ITS90 (0.0385 W/W°C) and JIS C 1604 (0.0392 W/W°C)
- Balco 500 -30°C ~ 120°C
- Ni 518 -80°C ~ 100°C
- 0°C ~ 100°C
- Accuracy@25°C* ± 0.1% or better
- High speed mode@25°C ± 0.5% or better
- Span Drift* ± 25 ppm/°C
- Zero Drift* ± 6 μV/°C

* Spec are based on 10SPS (total)

- Resolution 16-bit
- Sampling Rate 10 sample/second (total)
- High speed mode: 1K sample/second (total)
- CMR @ 50/60 HZ 90dB
- NMR @ 50/60 HZ 60dB
- * high speed mode does not support CMR/NMR
- Wire Burnout Detection

Ordering Information

- ADAM-6015 7-ch Isolated RTD Input Modbus TCP Module

Specifications

Analog Input

- Channels 8 (differential)
- Input Impedance > 10 MΩ (voltage)
- 120 Ω (current)
- Input Type mV, V, mA
- Input Range

±150mV, ±500mV, ±1V, ±5V, ±10V, 0 ~ 150mV, 0 ~ 500mV, 0 ~ 1V, 0 ~ 5V, 0 ~ 10V, 0 ~ 20mA, 4 ~ 20mA, ±20mA
--
- Accuracy@25°C

±0.1% of FSR (voltage)
±0.2% of FSR (current)
High Speed Mode (250SPS)
±0.2% of FSR (voltage)
±0.3% of FSR (current)
- Span Drift ±25 ppm/°C
- Zero Drift ±6 μV/°C
- Resolution 16-bit
- Sampling Rate 10 or 100 or 250 sample/second (total)
- CMR @ 50/60 Hz 90dB
- NMR @ 50/60 Hz 67dB
- * 100/250 SPS does not support CMR/NMR
- Common-Mode Voltage 350V_{DC}

Digital Output

- Channels 2, open collector to 30 V, 100 mA max. load
- Power Dissipation 300 mW for each module
- Output Delay On: 100μs
Off: 150μs

Ordering Information

- ADAM-6017 8-ch Isolated AI with 2-ch DO Modbus TCP Module

Specifications

Analog Input

- Channels 8 (differential)
- Input Type Thermocouple
- Thermocouple Type and Range:

J	0 ~ 760°C	R	500 ~ 1,750°C
K	0 ~ 1,370°C	S	500 ~ 1,750°C
T	-100 ~ 400°C	B	500 ~ 1,800°C
E	0 ~ 1,000°C		

- Accuracy@25°C

Type J,K,E,R,S:	±0.1% FSR Max
Type B:	±0.15% FSR Max
Type T:	±0.2% FSR Max
- Span Drift ±25 ppm/°C
- Zero Drift ±6 μV/°C
- Resolution 16-bit
- Sampling Rate 10 sample/second (total)
- Wire Burnout Detection

Ordering Information

- ADAM-6018+ 8-ch Isolated Thermocouple Input Module

Common Specifications

General

- Certification CE, FCC, UL
*Class I, Division 2, Groups A, B, C and D Hazardous Locations for ADAM-6015 and ADAM-6017
- LAN 10/100Base-T(X)
- Power Consumption 2.5 W @ 24 V_{DC} (ADAM-6015)
2.7 W @ 24 V_{DC} (ADAM-6017)
1 W @ 24 V_{DC} (ADMA-6018+)
- Connectors 1 x RJ-45 (LAN), Plug-in screw terminal block (I/O and power)

- Watchdog System (1.6 second) and Communication (programmable)
- 10 ~ 30 V_{DC}
- Power Input
- Supports Peer-to-Peer
- Supports GCL
- Supports Modbus/TCP, TCP/IP, UDP, RESTful
- Supports MQTT (D version), SNMP (D version) Protocols (ADAM-6017 and ADAM-6018+)

Protection

- Isolation Protection 2,000 V_{DC}
- Built-in TVS/ESD Protection
- Power Reversal Protection

Environment

- Operating Temperature -10 ~ 70°C (14 ~ 158°F)
-40 ~ 70°C (-40 ~ 158°F) (D version)
- Storage Temperature -20 ~ 80°C (-4 ~ 176°F)
-40 ~ 85°C (-40 ~ 185°F) (D version)
- Operating Humidity 20 ~ 95% RH (non-condensing)
- Storage Humidity 0 ~ 95% RH (non-condensing)

ADAM-6022

ADAM-6024

Ethernet-based Dual-loop PID Controller

12-ch Isolated Universal Input/Output Modbus TCP Module



ADAM-6022



Specifications

General

- Loop Number 2 (3 AI, 1 AO, 1 DI, 1 DO for each control loop)

Analog Input

- Channels 6 (differential)
- Input Range $\pm 10 V_{DC}$, 0 ~ 20 mA, 4 ~ 20 mA

Analog Output

- Channels 2
- Output Type V, mA
- Output Range 0 ~ 10 V_{DC} , 4 ~ 20 mA, 0 ~ 20 mA

Digital Input

- Channels 2
- Dry Contact Logic level 0: close to GND
Logic level 1: open
- Wet Contact Logic level 0: 0 ~ 3 V_{DC}
Logic level 1: 10 ~ 30 V_{DC}

Digital Output

- Channels 2, open collector to 30 V, 100 mA max. load
- Power Dissipation 300 mW for each module

Ordering Information

- ADAM-6022 Ethernet-based Dual-loop PID Controller



ADAM-6024



Specifications

Analog Input

- Channels 6 (differential)
- Input Range $\pm 10 V_{DC}$, 0 ~ 20 mA, 4 ~ 20 mA

Analog Output

- Channels 2
- Output Type V, mA
- Output Range 0 ~ 10 V_{DC} , 4 ~ 20 mA, 0 ~ 20 mA
- Support Analog AI to AO Linear Mapper (2-ch) for all input/output range

Digital Input

- Channels 2
- Dry Contact Logic level 0: close to GND
Logic level 1: open
- Wet Contact Logic level 0: 0 ~ 3 V_{DC}
Logic level 1: 10 ~ 30 V_{DC}
Sink (NPN)
- Support DO type

Digital Output

- Channels 2, open collector to 30 V, 100 mA max. load
- Power Dissipation 300 mW for each module

Supports

- Peer-to-Peer (Receiver only)
- GCL (Receiver only)

Ordering Information

- ADAM-6024 12-ch Isolated Universal I/O Modbus TCP Module

Common Specifications

General

- Certification CE, FCC, UL
- LAN 10/100Base-T(X)
- Power Consumption 4 W @ 24 V_{DC}
- Connectors 1 x RJ-45 (LAN), Plug-in screw terminal block (I/O and power)
- Watchdog System (1.6 second) and Communication (programmable)
- Power Input 10 ~ 30 V_{DC}
- Supports Modbus/TCP, TCP/IP, UDP, RESTful (D version), MQTT (D version), SNMP (D version)

Analog Input

- Input Impedance 20 M Ω

Accuracy@25°C

- $\pm 0.1\%$ of FSR (voltage)
- $\pm 0.2\%$ of FSR (current)
- High Speed Mode (250SPS)
- $\pm 0.2\%$ of FSR (voltage)
- $\pm 0.3\%$ of FSR (current)
- 16-bit
- 10 sample/second (Total)
- (ADAM-6024) 10/100/250 sample/second (Total)
- 90dB
- 67dB
- CMR @ 50/60 HZ
- NMR @ 50/60 HZ
- * 100/250 SPS does not support
- Span Drift $\pm 25 \text{ ppm}/^\circ\text{C}$
- Zero Drift $\pm 6 \mu\text{V}/^\circ\text{C}$

Analog Output

- Accuracy $\pm 0.1\%$ of FSR
- Resolution 12-bit, 16-bit (ADAM-6024)
- Drift $\pm 50 \text{ ppm}/^\circ\text{C}$

- Current Load Resistor Max. 500 Ω
- Voltage Load Resistor Min. 1K Ω

Protection

- Isolation Protection 2,000 V_{DC}
- Built-in TVS/ESD Protection
- DI Over Voltage Protection 35 V_{DC}
- Power Reversal Protection

Environment

- Operating Temperature -10 ~ 50°C (14 ~ 122°F)
D version: -40 ~ 70°C (-40~158°F)
- Storage Temperature -20 ~ 80°C (-4 ~ 176°F)
D version: -40 ~ 80°C (-40~176°F)
- Operating Humidity 20 ~ 95% RH (non-condensing)
- Storage Humidity 0 ~ 95% RH (non-condensing)

ADAM-6050

ADAM-6051

ADAM-6052

18-ch Isolated Digital I/O Modbus TCP Module

14-ch Isolated Digital I/O Modbus TCP Module with 2-ch Counter

16-ch Source-type Isolated Digital I/O Modbus TCP Module

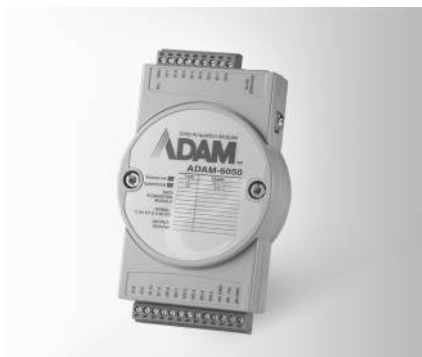

ADAM-6050

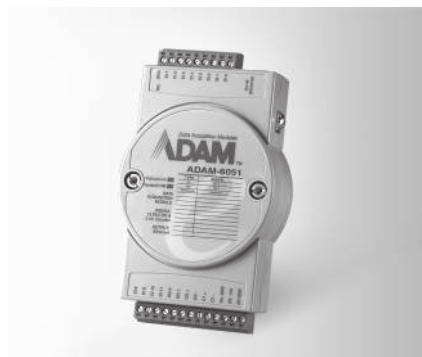

ADAM-6051

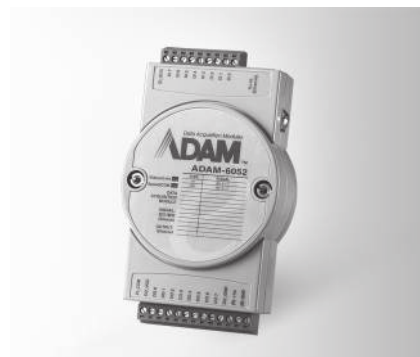

ADAM-6052



Specifications

Digital Input

- **Channels** 12
- **Dry Contact** Logic level 0: Closed to GND
Logic level 1: Open
- **Wet Contact** Logic level 0: 0 ~ 3 V_{DC}
Logic level 1: 10 ~ 30 V_{DC} or floating
Support DO type: Sink (NPN)
- **Supports 3 kHz Counter Input (32-bit + 1-bit overflow)**
- **Keep/Discard Counter Value when Power-off**
- **Supports 3 kHz Frequency Input**
- **Supports Inverted DI Status**

Digital Output

- **Channels** 6 (sink type), open collector to 30 V, 100 mA maximum load
- **Supports 5 kHz Pulse Output**
- **Supports High-to-Low and Low-to-High Delay Output**

Ordering Information

- **ADAM-6050** 18-ch Isolated DI/O Modbus TCP Module

Specifications

Digital Input

- **Channels** 12
- **Dry Contact** Logic level 0: Closed to GND
Logic level 1: Open
- **Wet Contact** Logic level 0: 0 ~ 3 V_{DC}
Logic level 1: 10 ~ 30 V_{DC} or floating
Support DO type: Sink (NPN)
- **Supports 3 kHz Counter Input (32-bit + 1-bit overflow)**
- **Keep/Discard Counter Value when Power-off**
- **Supports 3 kHz Frequency Input**
- **Supports Inverted DI Status**

Counter Input

- **Channels** 2
- **Mode** Counter, Frequency
- **Keep/Discard Counter Value when Power-off**
- **Maximum Count** 4,294,967,295 (32-bit + 1-bit overflow)
- **Input Frequency** Frequency Mode: 0.2 ~ 4500 Hz
Counter Mode: 0 ~ 4.5 kHz

Digital Output

- **Channels** 2 (sink type), open collector to 30 V, 100 mA maximum load
- **Supports 5 kHz Pulse Output**
- **Supports High-to-Low and Low-to-High Delay Output**

Ordering Information

- **ADAM-6051** 16-ch Isolated DI/O with Counter Modbus TCP Module

Specifications

Digital Input

- **Channels** 8
Dry/Wet Contact decided by switch or jumper
- **Dry Contact** Logic level 0: Open
Logic level 1: Closed to GND
- **Wet Contact** Logic level 0: 0 ~ 3 V_{DC} or floating
Logic level 1: 10 ~ 30 V_{DC}
Support DO type: Sink (NPN) or Source (PNP)
- **Supports 3 kHz Counter Input (32-bit + 1-bit overflow)**
- **Keep/Discard Counter Value when Power-off**
- **Supports 3 kHz Frequency Input**
- **Supports Inverted DI Status**

Digital Output

- **Channels** 8 (Source Type)
- **Voltage Range** 10 ~ 35 V_{DC}
- **Current** 1 A (per channel)
- **Supports 5 kHz Pulse Output**
- **Supports High-to-Low and Low-to-High Delay Output**
- **Supports Over Current Protection**

Ordering Information

- **ADAM-6052** 16-ch Source-type Isolated DI/O Modbus TCP Module

Common Specifications

General

- **Certification** FCC, CE, UL
*Class I, Division 2, Groups A, B, C and D Hazardous Locations
- **LAN** 1-port 10/100Base-T(X)
- **Power Consumption** 2 W @ 24 V_{DC}
- **Connectors** 1 x RJ-45 (LAN), Plug-in screw terminal block (I/O and power)
- **Watchdog** System (1.6 second) and Communication (programmable)

- **Power Input** 10 ~ 30 V_{DC}
- **Supports Peer-to-Peer, GCL**
- **Supports User Defined Modbus Address**
- **Supports Modbus/TCP, TCP/IP, UDP, RESTful, MQTT (D version), SNMP (D version) Protocol**

Protection

- **Power Reversal Protection**
- **Isolation Protection** 2,000 V_{DC}

Environment

- **Operating Temperature** -20 ~ 70°C (-4 ~ 158°F)
D version -40 ~ 70°C (-40 ~ 158°F)
- **Storage Temperature** -30 ~ 80°C (-22 ~ 176°F)
D version -40 ~ 85°C (-40 ~ 185°F)
- **Operating Humidity** 20 ~ 95% RH (non-condensing)
- **Storage Humidity** 0 ~ 95% RH (non-condensing)

ADAM-6060

ADAM-6066

6-ch Digital Input and 6-ch Relay
Modbus TCP Module

6-ch Digital Input and 6-ch Power Relay
Modbus TCP Module

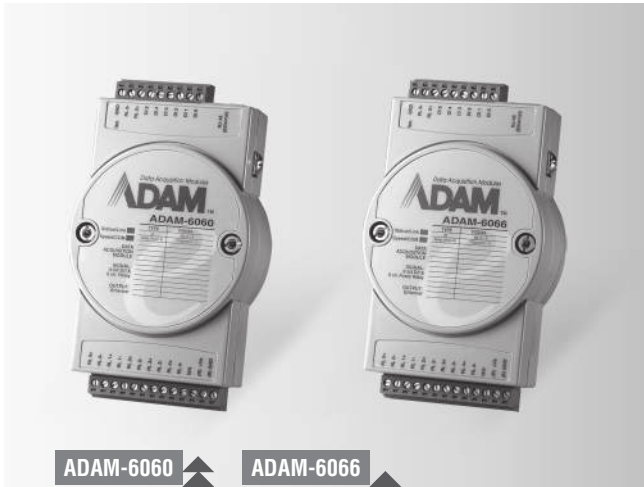

ADAM-6060

ADAM-6066



Specifications

General

- LAN 1-port 10/100Base-T(X)
- Power Consumption 2 W @ 24 V_{DC} (ADAM-6060)
2.5 W @ 24 V_{DC} (ADAM-6066)
- Connectors 1 x RJ-45 (LAN), Plug-in screw terminal block (I/O and power)
- Watchdog Timer System (1.6 second) and Communication (programmable)
- Power Input 10 ~ 30 V_{DC}
- Supports Peer-to-Peer
- Supports GCL
- Supports Modbus/TCP, TCP/IP, UDP, DHCP, SNMP, RESTful and MQTT Protocol

Digital Input

- Channels 6
- Dry Contact Logic level 0: Closed to GND
Logic level 1: Open
Logic level 0: 3 V_{DC}
- Wet Contact Logic level 1: 10 ~ 30 V_{DC} or floating
Support DO type: Sink (NPN) only
- Supports 3 kHz Counter Input (32-bit + 1-bit overflow)
- Keep/Discard Counter Value when Power-off
- Supports 3 kHz Frequency Input
- Supports Inverted DI Status

Relay Output (Form A)

- Channels 6
- Contact Rating (Resistive) ADAM-6060: 120 V_{AC} @ 0.5 A
30 V_{DC} @ 1 A
ADAM-6066: 250 V_{AC} @ 5 A
30 V_{DC} @ 3 A
- Breakdown Voltage 500 V_{AC} (50/60 Hz)
- Relay On Time 7 ms
- Relay Off Time 3 ms
- Total Switching Time 10 ms
- Insulation Resistance 1 GΩ min. at 500 V_{DC}
- Maximum Switching Rate (at rated load) 20 operations/minute
- Supports Pulse Output

Protection

- Isolation Voltage 2,000 V_{DC}
- Power Reversal Protection

Environment

- Operating Temperature -40 ~ 70°C (-40~158°F)
- Storage Temperature -40 ~ 80°C (-40~176°F)
- Operating Humidity 20 ~ 95% RH (non-condensing)
- Storage Humidity 0 ~ 95% RH (non-condensing)

Ordering Information

- ADAM-6060 6-ch DI and 6-ch Relay Modbus TCP Module
- ADAM-6066 6-ch DI and 6-ch Power Relay Modbus TCP Module

ADAM-6000 / 6200 Series Dimensions

Unit: mm

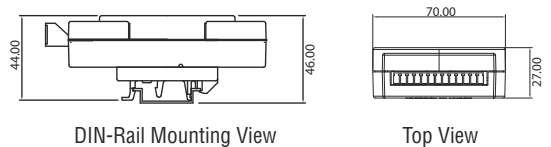
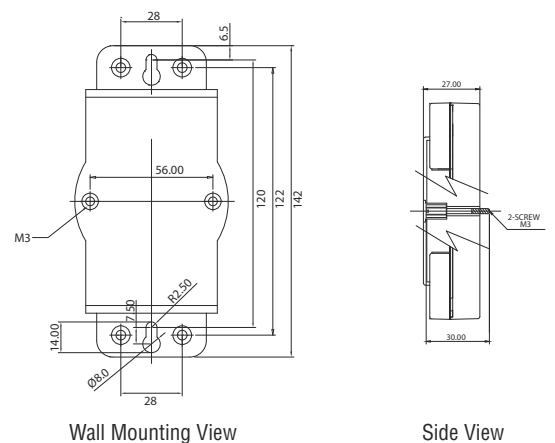
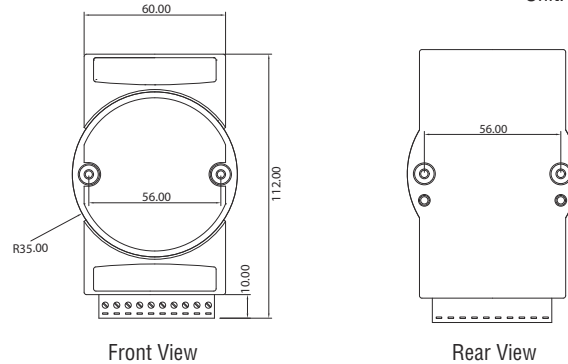

ADAM-6000 Series Common Specifications

General

- Dimensions (W x H x D) 70 x 120 x 30 mm
- Enclosure ABS+PC
- Mounting DIN 35 rail, stack, wall

ADAM-6000 Accessories

- 1652005959-01 13P 3.81mm 90D(F) terminal plug-in block
- 1652005963-01 9P 3.81mm 90D(F) terminal plug-in block
- 1997000000 Din-rail mounting kit
- 1999001090 Panel mounting kit

*Already in box, contact our sales for ordering if needed

ADAM-6217

ADAM-6224

8-ch Isolated Analog Input Modbus TCP Module

4-ch Isolated Analog Output Modbus TCP Module



ADAM-6217



Specifications

Analog Input

- **Channels** 8 (differential)
- **Input Impedance** > 10 M Ω (voltage)
120 Ω (current)
- **Input Type** mV, V, mA
- **Input Range** ± 150 mV, ± 500 mV, ± 1 V, ± 5 V, ± 10 V,
0~150 mV, 0~500 mV, 0~1 V, 0~5 V,
0~10 V, 0~20 mA, 4~20 mA, ± 20 mA
- **Span Drift** ± 30 ppm/ $^{\circ}$ C
- **Zero Drift** ± 6 μ V/ $^{\circ}$ C
- **Resolution** 16-bit
- **Accuracy@25 $^{\circ}$ C** $\pm 0.1\%$ of FSR (voltage)
 $\pm 0.2\%$ of FSR (current)
High Speed Mode (250SPS)
 $\pm 0.2\%$ of FSR (voltage)
 $\pm 0.3\%$ of FSR (current)
- **Sampling Rate** 10 or 100 or 250 sample/second (total)
- **CMR @ 50/60 Hz** 92 dB
- **NMR @ 50/60 Hz** 67 dB
- **Common Mode** 200 V_{DC}

Ordering Information

- **ADAM-6217** 8-ch Isolated Analog Input Modbus TCP Module



ADAM-6224



Specifications

Analog Output

- **Channels** 4
- **Output Impedance** 2.1 Ω
- **Output Settling Time** 20 μ s
- **Driving Load** Voltage: 2k Ω
Current: 500 Ω
- **Programmable Output Slope** 0.125 ~ 128 mA/sec
- **Output Type** 0.0625 ~ 64 V/sec
- **Output Range** V, mA
- **Accuracy** 0 ~ 5 V, 0 ~ 10 V, ± 5 V, ± 10 V, 0 ~ 20 mA, 4 ~ 20 mA
 $\pm 0.3\%$ of FSR (Voltage) at 25 $^{\circ}$ C
 $\pm 0.5\%$ of FSR (Current) at 25 $^{\circ}$ C
- **Resolution** 16-bit (12-bit compatible)
- **Current Load Resistor** 0 ~ 500 Ω
- **Drift** ± 50 ppm/ $^{\circ}$ C

Digital Input

- **Channels** 4 (Dry Contact only)
- **Dry Contact** Logic 0: Open
Logic 1: Closed to DGND
- **Support DI Filter**
- **Support Inverted DI Status**
- **Support Trigger to Startup or Safety Value**

Ordering Information

- **ADAM-6224** 4-ch Isolated Analog Output Modbus TCP Module

Common Specifications

General

- **Ethernet** 2-port 10/100 Base-TX (for Daisy Chain)
- **Protocol** Modbus TCP, TCP/IP, UDP, HTTP, DHCP, RESTful, SNMP (B version), MQTT (B version)
- **Connector** Plug-in 5P/15P screw terminal blocks
- **Power Input** 10 ~ 30 V_{DC} (24 V_{DC} standard)
- **Watchdog Timer** System (1.6 seconds)
Communication (Programmable)
- **Dimensions** 70 x 122 x 27 mm
- **Protection** Built-in TVS/ESD protection
Power Reversal protection
Isolation protection: 2500 V_{DC}
- **Power Consumption** ADAM-6217: 3.5W @ 24 V_{DC}
ADAM-6224: 6W @ 24 V_{DC}

Features

- Daisy chain connection with auto-bypass protection
- Remote monitoring and control with smart phone/pad
- Group configuration capability for multiple module setup
- Flexible user-defined Modbus address
- Intelligent control ability by Peer-to-Peer and GCL function
- Multiple protocol support: Modbus TCP, TCP/IP, UDP, HTTP, DHCP, RESTful, SNMP (B version), MQTT (B version)
- Web language support: XML, HTML 5, Java Script
- System configuration backup
- User Access Control

Environment

- **Operating Temperature** -10 ~ 70 $^{\circ}$ C (14 ~ 158 $^{\circ}$ F)
-40 ~ 70 $^{\circ}$ C (-40 ~ 158 $^{\circ}$ F) (B version)
- **Storage Temperature** -20 ~ 80 $^{\circ}$ C (-4 ~ 176 $^{\circ}$ F)
-40 ~ 85 $^{\circ}$ C (-40 ~ 185 $^{\circ}$ F) (B version)
- **Operating Humidity** 20 ~ 95% RH (non-condensing)
- **Storage Humidity** 0 ~ 95% RH (non-condensing)

ADAM-6250

ADAM-6251

ADAM-6256

15-ch Isolated Digital I/O Modbus TCP Module

16-ch Isolated Digital Input Modbus TCP Module

16-ch Isolated Digital Output Modbus TCP Module

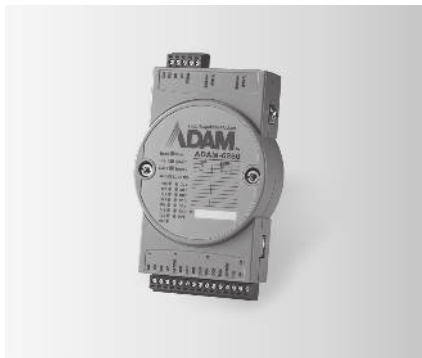

ADAM-6250



ADAM-6251



ADAM-6256



Specifications

Digital Input

- **Channels** ADAM-6250: 8
ADAM-6251: 16
- **Dry Contact** Logic 0: Open
Logic 1: Closed to DGND
- **Wet Contact** Logic 0: 0 ~ 3 VDC or 0 ~ -3 VDC
Logic 1: 10 ~ 30 VDC or -10 ~ -30 VDC
(Dry/Wet Contact decided by Switch)
Support DO type: Sink (NPN) or Source (PNP)
- **Input Impedance** 5.2 kΩ (Wet Contact)
- **Transition Time** 0.2 ms
- **Frequency Input Range** 0.1 ~ 3kHz
- **Counter Input** 3kHz (32 bit + 1 bit overflow)
- **Keep/Discard Counter Value when power off**
- **Supports Inverted DI Status**

Channels

ADAM-6250: 7 (Sink Type)
ADAM-6256: 16 (Sink Type)

- **Output Voltage Range** 10 ~ 30 V_{DC}
- **Normal Output Current** 100 mA (per channel)
- **Pulse Output** Up to 5kHz
- **Delay Output** High-to-Low and Low-to-High

Ordering Information

- **ADAM-6250** 15-ch Isolated Digital I/O Modbus TCP Module
- **ADAM-6251** 16-ch Isolated Digital Input Modbus TCP Module
- **ADAM-6256** 16-ch Isolated Digital Output Modbus TCP Module

Digital Output

Common Specifications

General

- **Certification** CE,FCC,UL
- **Ethernet** 2-port 10/100 Base-TX (for Daisy Chain)
- **LED Indication** ADAM-6250: 8 DI + 7 DO
ADAM-6251: 16 DI
ADAM-6256: 16 DO
- **Protocol** Modbus/TCP, TCP/IP, UDP, HTTP, DHCP, MQTT, SNMP
- **Connector** Plug-in 5P/15P screw terminal blocks
- **Power Input** 10 ~ 30 V_{DC} (24 V_{DC} standard)
- **Watchdog Timer** System (1.6 seconds)
Communication (Programmable)
- **Dimensions** 70 x 122 x 27 mm
- **Protection** Built-in TVS/ESD protection
Power Reversal protection
Over Voltage protection: +/- 35V_{DC}
Isolation protection: 2500 V_{DC}
- **Power Consumption** ADAM-6250: 3 W @ 24 V_{DC}
ADAM-6251: 2.7 W @ 24 V_{DC}
ADAM-6256: 3.2 W @ 24 V_{DC}

Features

- Daisy chain connection with auto-bypass protection
- Remote monitoring and control with smart phone/pad
- Group configuration capability for multiple module setup
- DI/O LED Indication
- Flexible user-defined Modbus address.
- Intelligent control ability by Peer-to-Peer and GCL function
- Multiple protocol support: Modbus/TCP, TCP/IP, UDP, HTTP, DHCP, MQTT, SNMP
- Web language support: XML, HTML 5, Java Script
- System configuration backup
- User Access Control

Environment

- **Operating Temperature** -10 ~ 70°C (14 ~ 158°F)
-40 ~ 70°C (-40~158°F) (B version)
- **Storage Temperature** -20 ~ 80°C (-4 ~ 176°F)
-40 ~ 80°C (-40~176°F) (B version)
- **Operating Humidity** 20 ~ 95% RH (non-condensing)
- **Storage Humidity** 0 ~ 95% RH (non-condensing)

ADAM-6260

ADAM-6266

6-ch Relay Output Modbus TCP Module

4-ch Relay Output Modbus TCP Module with 4-ch DI

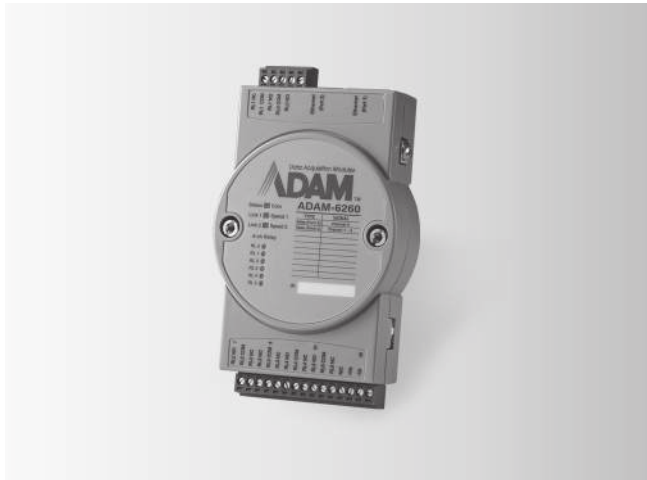

ADAM-6260



ADAM-6266



Specifications

Relay Output

- **Channels**
ADAM-6260: 5 Form C and 1 Form A
ADAM-6266: 4 Form C
- **Contact Rating (Resistive)**
250 V_{AC} @ 5A
30 V_{DC} @ 5A
- **Max. Switching Voltage**
400 V_{AC}
300 V_{DC}
- **Breakdown Voltage**
500 V_{AC} (50/60Hz)
- **Max. Breakdown Capacity**
1250 VA
- **Frequency of Operation**
360 operations/hour with load
72,000 operations/hour without load
- **Set/Reset Time**
8 ms/8 ms
- **Mechanical Endurance**
> 15 x 10⁶ operations
- **Isolation between Contact**
1000 V_{rms}
- **Insulation Resistance**
> 10 G.Ω @ 500 V_{DC}

Digital Input

- **Channels**
ADAM-6266: 4
- **Dry Contact**
Logic 0: Open
Logic 1: Closed to DI COM

- **Wet Contact**
Logic 0: 0 ~ 3 VDC or 0 ~ -3 VDC
Logic 1: 10 ~ 30 VDC or -10 ~ -30 VDC
(Dry/Wet Contact decided by Switch)
Support DO type: Sink (NPN) or Source (PNP)
5.2 kΩ (Wet Contact)
- **Input Impedance**
0.2 ms
- **Transition Time**
0.1 ~ 3kHz
- **Frequency Input Range**
3kHz (32 bit + 1 bit overflow)
- **Counter Input**
3kHz (32 bit + 1 bit overflow)
- **Keep/Discard Counter Value when power off**
- **Supports Inverted DI Status**

Ordering Information

- **ADAM-6260** 6-ch Relay Output Modbus TCP Module
- **ADAM-6266** 4-ch Relay Output Modbus TCP Module with 4-ch DI

ADAM-6200 Accessories

- **1652005986-01** 15P 3.5mm 90D(F) terminal plug-in block
- **1652005987-01** 5P 3.5mm 90D(F) terminal plug-in block
- **1997000000** Din-rail mounting kit
- **1999001090** Panel mounting kit

*Already in box, contact our sales for ordering if needed

Common Specifications

General

- **Ethernet** 2-port 10/100 Base-TX (for Daisy Chain)
- **LED Indication**
ADAM-6260: 6 RL
ADAM-6266: 4 RL + 4 DI
- **Protocol**
Modbus/TCP, TCP/IP, UDP, HTTP, DHCP, SNMP, MQTT
- **Connector** Plug-in 5P/15P screw terminal blocks
- **Power Input** 10 - 30 V_{DC} (24 V_{DC} standard)
- **Watchdog Timer** System (1.6 seconds)
Communication (Programmable)
- **Dimensions** 70 x 122 x 27 mm
- **Protection** Built-in TVS/ESD protection
Power Reversal protection
Over Voltage protection: +/- 35V_{DC}
Isolation protection: 2500 V_{DC}
ADAM-6260: 4.5 W @ 24 V_{DC}
ADAM-6266: 4.2 W @ 24 V_{DC}
- **Power Consumption**

Features

- Daisy chain connection with auto-bypass protection
- Remote monitoring and control with smart phone/pad
- Group configuration capability for multiple module setup
- DI/O LED Indication
- Flexible user-defined Modbus address.
- Intelligent control ability by Peer-to-Peer and GCL function
- Multiple protocol support: Modbus/TCP, TCP/IP, UDP, HTTP, DHCP, SNMP, MQTT
- Web language support: XML, HTML 5, Java Script
- System configuration backup
- User Access Control

Environment

- **Operating Temperature** -10 ~ 70°C (14 ~ 158°F)
-40 ~ 70°C (-40~158°F) (B version)
- **Storage Temperature** -20 ~ 80°C (-4 ~ 176°F)
-40 ~ 80°C (-40~176°F) (B version)
- **Operating Humidity** 20 ~ 95% RH (non-condensing)
- **Storage Humidity** 0 ~ 95% RH (non-condensing)

ADAM-6315

ADAM-6317

IoT OPC UA Ethernet I/O - RTD Module

IoT OPC UA Ethernet I/O - AI Module



ADAM-6315



Specifications

Analog Input

- Channels 8 (differential)
 - Input Impedance > 10 MΩ
 - Input Connections 2 or 3 wire
 - Input Type Pt, Balco and Ni RTD
 - RTD Types and Temperature Ranges
 - Pt 100
 - 50°C - 150°C
 - 0°C - 100°C
 - 0°C - 200°C
 - 0°C - 400°C
 - 100°C - 100°C
 - 200°C - 200°C
- *Supports both IEC 60751 ITS90 (0.00385Ω/Ω/°C) and JIS C 1604 (0.00392Ω/Ω/°C)
- Pt 1000
 - 40°C - 160°C
 - Balco 500
 - 30°C - 120°C
 - Ni 508
 - 0°C - 100°C
 - Ni 518
 - 80°C - 100°C
- Accuracy ± 0.1 % or better
High speed mode ± 0.5% or better
 - Span Drift ± 25 ppm/°C
 - Zero Drift ± 6 μV/°C
 - Resolution 16-bit
 - Sampling Rate Normal speed mode: 10 sample/second (total)
High speed mode: 1024 sample/second (total)
CMR: 90 dB @ 50/60 HZ
NMR: 60 dB @ 50/60 HZ

* High speed mode does not support CMR/NMR

Wire Burnout Detection

Digital Input

- Channels 6
- Dry contact logic 0: Open; logic 1: Closed to ground
- Wet contact logic 0: 0 - 3 V_{cc} or floating; logic 1: 10 - 30 V_{cc}
- Support DO type: Sink (NPN) and Source (PNP)
- DI0-DI5 support 3 kHz counter input
- DI0-DI5 support 3 kHz frequency input

Digital Output

- Channels 8
- Output type Sink type, 30 V_{cc}, 0.1A max. per channel
- DO2-DO7 support 3 kHz pulse output

Ordering Information

- ADAM-6315 OPC UA and Security Remote I/O - RTD Module

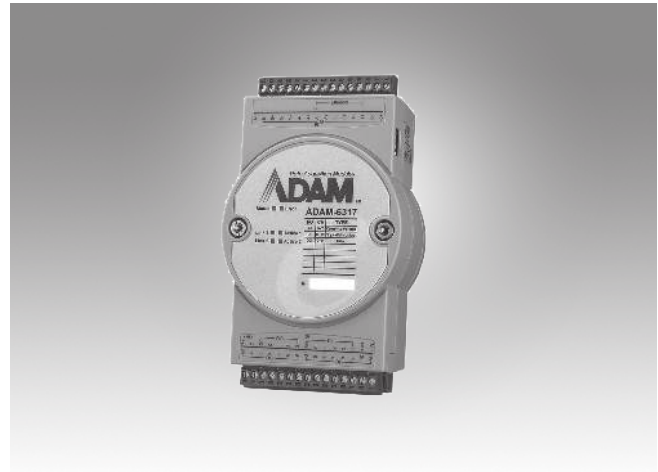

ADAM-6317



Specifications

Analog Input

- Channels 8 (differential)
- Sampling Rate 10 or 100 samples/second (total)
- Resolution 16 bits
- Input Range 0 - 150mV, 0 - 500mV,
0 - 1V, 0 - 5V, 0 - 10V,
±150 mV, ±500 mV, ±1V,
±5 V, ±10 V, ±20 mA,
0 - 20 mA, 4 - 20mA

Digital Input

- Channels 11
- Dry contact logic 0: Open
logic 1: Closed to ground
logic 0: 0 - 3 V_{cc} or floating
logic 1: 10 - 30 V_{cc}
- Support DO type: Sink (NPN) and Source (PNP)
- DI5-DI10 support 3 kHz counter input
- DI5-DI10 support 3 kHz frequency input

Digital Output

- Channels 10
- Output type Sink type, 30 V_{cc},
0.1A max. per channel
- DO4-DO9 support 3 kHz pulse output

Ordering Information

- ADAM-6317 OPC UA and Security Remote I/O - AI Module

Common Specifications

General

- Power input 10 - 30 V_{cc}
- Power Consumption 2.9 W @ 24 V_{cc} (ADAM-6317)
2.8 W @ 24 V_{cc} (ADAM-6350)
- LAN port 2-port 10/100 Base-T(X) (for Daisy Chain)
- Connectors 2 x RJ-45 (LAN), Plug-in screw terminal block (I/O and power)
- Watchdog System and Communication
- Protocol OPC UA, Modbus

Protection

- Isolation 2,500 V_{cc}
- Power Reversal Protection

OPC UA

- Max Monitored Items 600 (A maximum of 32 ScaledValueHistory items can be included in all sessions) (ADAM-6315)
- Max Sessions 4 (including security or non-security session)
- Max Subscriptions per Session 1
- Support security/certificate management

Modbus/TCP

- Modbus/TCP connection 4

Environment

- Operating Temperature -25°C - 70°C
- Storage Temperature -25°C - 85°C
- Operating Humidity 20 - 95% RH (non-condensing)
- Storage Humidity 0 - 95% RH (non-condensing)

ADAM-6350

ADAM-6360D

ADAM-6366

IoT OPC UA Ethernet I/O - DI/O Module

IoT OPC UA Ethernet I/O - SSR Relay Output Module

IoT OPC UA Ethernet I/O - SSR Relay Output Module

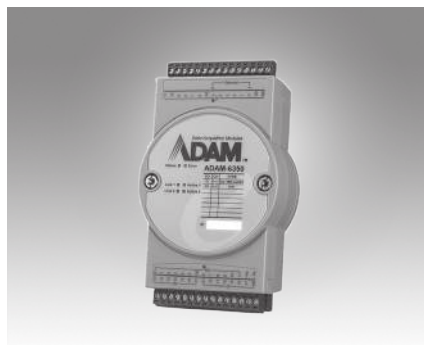

ADAM-6350



ADAM-6360D



ADAM-6366



Specifications

Digital Input

- Channels 18
- Dry contact logic 0: Open
logic 1: Closed to ground
- Wet contact logic 0: 0 ~ 3 V_{DC} or floating
logic 1: 10 ~ 30 V_{DC}
Support DO type:
Sink (NPN) and Source (PNP)
- DI12~DI17 support 3 kHz counter input
- DI12~DI17 support 3 kHz frequency input

Digital Output

- Channels 18
- Output type Sink type, 30 V_{DC},
0.1A max. per channel
- DO12~DO17 support 3 kHz pulse output

Specifications

Relay Output (PhotoMOS SPST)

- Channels 8 (Form A)
- Contact rating (Resistive and Inductive load) 1 A @25°C @30 V_{DC}
0.7A @70°C @30 V_{DC}
- Relay-on time 1.3 ms
- Relay-off time 0.8 ms
- Isolation (Relay output to power) 1500Vrms
- Peak Load Current 4A (100ms (1 pulse))
- Total Power Dissipation 400mW / channel
- On-state resistance 0.5Ω

Digital Input

- Channels 14
- Dry contact logic 0: Open
logic 1: Closed to ground
- Wet contact logic 0: 0 ~ 3 V_{DC} or floating
logic 1: 10 ~ 30 V_{DC}
Support DO type:
Sink (NPN) and Source (PNP)
- DI8~DI13 support 3 kHz counter input
- DI8~DI13 support 3 kHz frequency input

Digital Output

- Channels 6
- Output type Sink type, 30 V_{DC},
0.1A max. per channel
- DO0~DO5 support 3 kHz pulse output

Specifications

Relay Output

- Channels 6 (Form A)
- Contact rating 0.25A@250V_{AC}
2A@30V_{DC}
- Relay-on time 3 ms
- Relay-off time 5 ms
- Electrical endurance at contact application Resistive, 0.25A@250V_{AC}:
1x10⁶ operations/min.
Resistive, 2A@30V_{DC}:
1x10⁶ operations/min.
- Insulation Resistance 1 GΩ

Digital Input

- Channels 18
- Dry contact logic 0: Open
logic 1: Closed to ground
- Wet contact logic 0: 0 ~ 3 V_{DC} or floating
logic 1: 10 ~ 30 V_{DC}
Support DO type:
Sink (NPN) and Source (PNP)
- DI12~DI17 support 3 kHz counter input
- DI12~DI17 support 3 kHz frequency input

Digital Output

- Channels 6
- Output type Sink type, 30 V_{DC},
0.1A max. per channel
- DO0~DO5 support 3 kHz pulse output

Common Specifications

General

- Power input 10 ~ 30 V_{DC}
- Power Consumption 2.8 W @ 24 V_{DC} (ADAM-6350)
2.8 W @ 24 V_{DC} (ADAM-6360D)
4.5 W @ 24 V_{DC} (ADAM-6366)
- LAN port 2-port 10/100 Base-T(X)
(for Daisy Chain)
- Connectors 2 x RJ-45 (LAN), Plug-in screw terminal block (I/O and power)
- Watchdog System and Communication
- Protocol OPC UA, Modbus

Protection

- Isolation 2,500 V_{DC}
- Power Reversal Protection

OPC UA

- Max Monitored Items 600
(including all sessions)
- Max Sessions 4 (including security or non-security session)
- Max Subscriptions per Session 1
- Support security/certificate management

Modbus/TCP

- Modbus/TCP connection 4

Environment

- Operating Temperature -25° C ~ 70° C
- Storage Temperature -25° C ~ 85° C
- Operating Humidity 20 ~ 95% RH
(non-condensing)
- Storage Humidity 0 ~ 95% RH
(non-condensing)

Ordering Information

- ADAM-6350 OPC UA and Security Remote I/O - DI/O Module
- ADAM-6360D OPC UA and Security Remote I/O - SSR Relay Output Module
- ADAM-6366 OPC UA and Security Remote I/O - SSR Relay Output Module

ADAM-6300 Accessories

- 1652005986-01 15P 3.5mm 90D(F) terminal plug-in block
- 1997000000 Din-rail mounting kit
- 1999001090 Panel mounting kit

*Already in box, contact our sales for ordering if needed

Ethernet I/O Modules: ADAM-6000



Model		ADAM-6015	ADAM-6017	ADAM-6018+	ADAM-6022	ADAM-6024
Interface		1x RJ-45 LAN port, 10/100 Mbps Ethernet				
Peer-to-Peer ¹			✓		–	Receiver Only ²
GCL ¹			✓		–	Receiver Only ²
Resolution			16-bit		16-bit for analog inputs 12-bit for analog outputs	16-bit for analog inputs 16-bit for analog outputs
Analog Input	Channels	7	8	8	6	6
	Sampling Rate	10 Hz	10/100/250 Hz	10 Hz	10 Hz	10/100/250 Hz
	Voltage Input	–	±150 mV, ±500 mV, ±1 V, ±5 V, ±10 V, 0~150 mV, 0~500 mV, 0~1 V, 0~5 V, 0~10 V	–	±10 V	±10 V
	Current Input	–	0~20 mA, 4~20 mA, ±20 mA	–	0~20 mA, 4~20 mA	0~20 mA, 4~20 mA
	Direct Sensor Input	Pt, Balco, and Ni RTD	–	J, K, T, E, R, S, B thermocouple	–	–
	Burn-out Detection	✓	✓ (4 ~ 20mA only)	✓	–	–
Functions		Max. Min. Avg.	Max. Min. Avg.	Max. Min. Avg.	–	AI to AO linear mapper (Support with 2-ch AO)
Analog Output	Channels	–	–	–	2	2
	Current Output	–	–	–	0~20, 4~20 mA @ 15 V _{DC}	0~20, 4~20 mA @ 15 V _{DC}
	Voltage Output	–	–	–	0~10 V _{DC} @ 30 mA	0~10 V _{DC} @ 30 mA
Digital I/O	Input Channels	–	–	–	2	2
	Output Channels	–	2 (sink)	8 (sink)	2 (sink)	2 (sink)
	High/Low Alarm Settings	✓	✓	✓	–	–
Isolation Protection			2,000 V _{DC}		2,000 V _{DC}	2,000 V _{DC}
Remark		–	–	–	Built-in dual loop PID control algorithm	–
Protocol		D version: Modbus TCP, RESTful, MQTT*, SNMP*, ASCII *ADAM-6015 not support			Modbus TCP	D version: Modbus TCP, RESTful, MQTT, SNMP, ASCII
Certification		CID2, UL, CE, FCC	CID2, UL, CE, FCC	UL, CE, FCC	CE, FCC	UL, CE, FCC



Model		ADAM-6050	ADAM-6051	ADAM-6052	ADAM-6060	ADAM-6066
Interface		1x RJ-45 LAN port, 10/100 Mbps Ethernet				
Peer-to-Peer ¹		✓	✓	✓	✓	✓
GCL ¹		✓	✓	✓	✓	✓
Digital I/O	Input Channels	12	12	8	6	6
	Output Channels	6 (sink)	2 (sink)	8 (source)	6-ch relay	6-ch power relay
	Extra Counter Channels	–	2	–	–	–
	Counter Input	3 kHz	4.5 kHz	3 kHz	3 kHz	3 kHz
	Frequency Input	3 kHz	4.5 kHz	3 kHz	3 kHz	3 kHz
	Pulse Output	✓	✓	✓	✓	✓
	High/Low Alarm Settings	–	–	–	–	–
Isolation Protection		2,000 V _{DC}				
Protocol		D version: Modbus TCP, RESTful, MQTT, SNMP, ASCII				
Certification		CID2, UL, CE, FCC	UL, CE, FCC	CID2, UL, CE, FCC	UL, CE, FCC	UL, CE, FCC

✓ : supported, – : not supported, Δ : optional

Ethernet I/O Modules: ADAM-6200



Model	ADAM-6217	ADAM-6224	ADAM-6250	ADAM-6251	ADAM-6256	ADAM-6260	ADAM-6266
Interface	2x RJ-45 LAN port (Daisy-chain), 10/100 Mbps Ethernet						
Peer-to-Peer ¹	✓	Receiver Only ²	✓	✓	✓	✓	✓
GCL ¹	✓	✓	✓	✓	✓	✓	✓
Analog Input	Channels	8	-	-	-	-	-
	Input Impedance	>10MΩ (voltage) 120Ω (current)	-	-	-	-	-
	Voltage Input	±150 mV, ±500 mV, ±1 V, ±5 V, ±10 V, 0~150 mV, 0~500 mV, 0~1 V, 0~5 V, 0~10 V	-	-	-	-	-
	Current Input	0~20 mA, 4~20 mA ±20 mA	-	-	-	-	-
	Sampling Rate	10/100/250 Hz	-	-	-	-	-
	Burn-out Detection	✓ (4~20 mA)	-	-	-	-	-
	Resolution	16-bit	-	-	-	-	-
	Accuracy	±0.1% of FSR (voltage)@25°C ±0.2% of FSR (current)@25°C High Speed Mode (250SPS) ±0.2% of FSR (voltage)@25°C ±0.3% of FSR (current)@25°C	-	-	-	-	-
Analog Output	Channels	-	4	-	-	-	-
	Voltage Output	-	0~5 V, 0~10 V, ±5 V, ±10 V	-	-	-	-
	Current Output	-	0~20 mA, 4~20 mA	-	-	-	-
	Resolution	-	12/16-bit	-	-	-	-
Digital I/O	Input Channels	-	4 (dry contact only)	8	16	-	4
	Output Channels	-	-	7 (sink)	-	16 (sink)	-
	Relay Output	-	-	-	-	-	1 x Form A, 5 x Form C
	Contact Rating	-	-	-	-	-	250 V _{AC} @ 5A 30 V _{DC} @ 5A
	Counter Input	-	-	3 kHz	3 kHz	-	-
	Frequency Input	-	-	3 kHz	3 kHz	-	-
	Pulse Output	-	-	5 kHz	-	5 kHz	5 kHz
LED Indicators	-	-	8 digital inputs, 7 digital outputs	16 digital inputs	16 digital outputs	6 relay	4 digital inputs, 4 relay
Power Consumption	3.5 W	6 W	3 W	2.7 W	3.2 W	4.5 W	4.2 W
Isolation Voltage	2,500 V _{DC}						
Watchdog Timer	System (1.6 s), Communication (programmable)						
Communication Protocol	Modbus TCP, RESTful, MQTT, SNMP, ASCII						
Power Requirements	10~30 V _{DC} (24 V _{DC} standard)						
Operating Temperature	-40 ~ 70°C (-40 ~ 158°F)						
Storage Temperature	-40 ~ 85°C (-40 ~ 185°F)						
Operating Humidity	20~95% RH (non-condensing)						
Storage Humidity	0~95% RH (non-condensing)						
Certification	UL, CE, FCC	UL, CE, FCC	UL, CE, FCC	UL, CE, FCC	UL, CE, FCC	UL, CE, FCC	UL, CE, FCC

Note 1: Peer-to-peer and GCL cannot be run simultaneously; only one feature can be enabled at a time.

Note 2: The ADAM-6224 can only act as a receiver and generate analog output when peer-to-peer or GCL mode is used.

✓: supported, -: not supported, Δ: optional

OPC UA Ethernet I/O Modules: ADAM-6300



Model		ADAM-6315	ADAM-6317	ADAM-6350	ADAM-6360D	ADAM-6366
Description		IoT OPC UA Ethernet I/O - RTD Input Module	IoT OPC UA Ethernet I/O - Analog Input Module	IoT OPC UA Ethernet I/O - Digital I/O Module	IoT OPC UA Ethernet I/O - SSR Relay Output Module	IoT OPC UA Ethernet I/O - Relay Output Module
General	Power Input	10~30 V _{DC}				
	LAN Port	2 x RJ-45 10/100 Mbps				
	Connectors	2 x RJ-45 (LAN), Plug-in screw terminal block (I/O and power)				
	Watchdog	System and Communication				
	Protocol	OPC UA, Modbus TCP				
Protection	Isolation	2500 V _{DC}				
	Power Reversal Protection	✓				
OPC UA	Max Monitored Items	600 (including all sessions)				
	Max Sessions	4 (including security or non-security session)				
	Max Subscriptions per Session	1				
	Support Security/Certificate Management	✓				
Modbus TCP Connections		4				
Environment	Operating Temperature	-25° ~ 70°C (-13 ~ 158°F)				
LED Indicator		Status, Error, Link, Active				
Analog Input	Channels	8	8	-	-	-
	Voltage Input	RTD: Pt 100, Pt 1000, Balco 500, Ni 518	0~150mV, 0~500mV, 0~1V, 0~5V, 0~10V, ±150 mV, ±500 mV, ±1V, ±5 V, ±10 V	-	-	-
	Current Input	-	0 ~ 20 mA, 4 ~ 20 mA, ± 20 mA	-	-	-
	Sampling Rate	10/1024 Hz (total)	10/100 Hz (total)	-	-	-
	Burn-out Detection	✓	✓ (4~20 mA)	-	-	-
	Resolution	16-bit	16-bit	-	-	-
Digital Input	Digital Input Channels	6	11	18	14	18
	Counter Input	3 kHz (DI4~DI9)	3 kHz (DI5~DI10)	3 kHz (DI12~DI17)	3 kHz (DI8~DI13)	3 kHz (DI12~DI17)
	Frequency Input	3 kHz (DI4~DI9)	3 kHz (DI5~DI10)	3 kHz (DI12~DI17)	3 kHz (DI8~DI13)	3 kHz (DI12~DI17)
Digital Output	Digital Output Channels	8	10	18	6	6
	Relay Output Channels	-	-	-	8 x Form A (SSR)	6 x Form A
	Contact Rating	-	-	-	1 A @25°C @ 30 V _{DC} 0.7A @70°C @30 V _{DC}	250 V _{AC} @ 0.25 A, 30 V _{DC} @ 2 A
	Pulse Output	3 kHz (DO4~DO9)	3 kHz (DO4~DO9)	3 kHz (DO12~DO17)	3 kHz (DO0~DO5)	3 kHz (DO0~DO5)
Analog Output	Channels	-	-	-	-	-
	Type	-	-	-	-	-
Certification		CE, FCC	CE, FCC	CE, FCC	CE, FCC	CE, FCC

✓ : supported, - : not supported, Δ : optional