

M12 Inner Push Pull

World's First M12 X-Coded Cordsets & Pigtails aligned with IEC 61076-2-010

PRODUCT BULLETIN 

The Lumberg Automation RP12M & PP12M M12 Push Pull Portfolio features a secure, fast-locking contacting method to prevent accidental disconnects that cause downtimes, disrupt data gathering or create safety hazards.

Quick and Secure Connections

The M12 Push Pull connectors & cordsets portfolio offers a tool-free, fast and secure connection, further reducing installation time and ensuring a reliable connection every time.

High Reliability

Designed to meet the IEC 61076-2-010 standard, these connectors ensure high reliability, even in the most demanding environments such as railway and classic machine building. This means less downtime and more productivity for your operations.

Compatibility

The NEW way of connecting devices ensures compatibility between all involved vendors and is backwards compatible with the well-known screw locking of M12 logic.

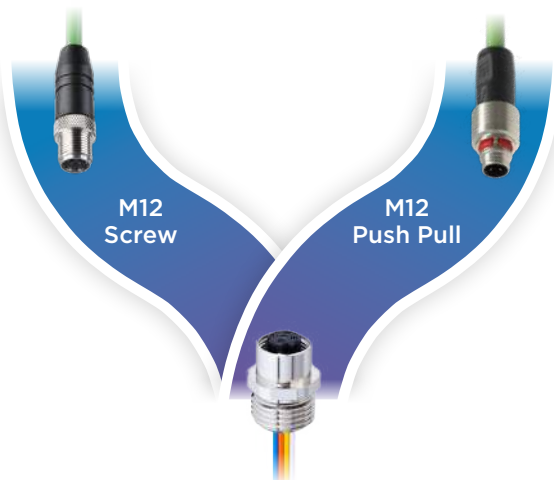

Socket Design Supports Standard Screw and Push Pull

PCB connection via THR, Wire or Solder (coming soon)



The Lumberg Automation M12 Push Pull portfolio offers a user-friendly contacting method, ensuring reliable signal and data transfer. Installation is quick and effortless: just push the connectors into the sockets—no tools or screwing required. As part of Belden's Rail Portfolio, this solution is compatible with BXP switches and stands out with its key features that prioritize efficiency and ease of use in demanding environments.



Key Features

- Inner Push Pull design according to IEC 61076-2-010 standard.
- Features the RP12M Push Pull for Rail Applications and the PP12M Push Pull for Standard Industrial Applications.
- Aligned to rail requirements according to EN 45545-2 and EN 50155.
- Reliable IP65 and IP67 ingress protection.
- X, D and A coding suited for data applications with up to 10 GB/s transmission rates.
- Prevent downtime with a reliable connection between information sender and receiver.



Receive your first M12 Push Pull Samples

Order No.	Sample
935304201	Combination Housing + Push Pull Pigtail

NEW Product Configuration Code, logic explanation:

Side 1:
PP12M-MSSV4D

Side 2:
PP12M-MSSV4D

Cable:
0342-0100

Codings:
 A = A-code (Sensor)
 B = B-Code (Fieldbus)
 C = C-Code (Sensor/Motor, Legacy Powering)
 D = D-Code (Fast Ethernet, 100 Mb/s)
 X = X-Code (Gigabit Ethernet, 1GB/s - 10 GB/s)

Pin / Poles:
 2 = 2-Pin
 3 = 3-Pin
 4 = 4-Pin
 5 = 5-Pin
 8 = 8-Pin

Specifics:
 V = Slot

Shielding:
 S = Shielded
 U = Unshielded

Version of Connector:
 S = Straight
 A = Angled

Gender:
 M = Male
 F = Female

Connector Construction Type:
 M = Molded Design
 F = Frontwall Mounting = Receptacle or Flange
 B = Back Mount = Receptacle or Flange
 I = IDC Termination = Field Attachable
 C = Crimp Termination = Field Attachable
 S = Screw Termination = Field Attachable

Size / Type:
 12 = Metric 12 / M12
 08 = Metric 8 / M8
 45 = RJ45 Register Jack **45**
 78 - 7/8"

Attachment Design:
 PP = Push Pull Standard
 NP = Nirosta Push Pull
 RP = Rolling Stock Push Pull
 RM = Rolling Stock Standard metric Screw
 SM = Standard Metric
 RJ = Registered Jack 45
 WP = Washdown Push Pull

Cable Length Definition:
 0010 = 0.1Meter, 10 cm
 0100 = 1Meter, 100 cm
 0200 = 2Meter, 200 cm
 0500 = 5Meter, 200 cm
 1000 = 10Meter, 1000 cm
 100M = 100Meter

Cable (STL) Number:
 0508 = STL 508 (Fast Ethernet Cat5e, Rolling Stock, shielded, EN 45545-2, X-FRNC, 0,34mm³, 4 wires, twisted pairs)
 0522 = STL 552 (Gigabit Ethernet Cat7, Rolling Stock, shielded, blue jacket, EN45545-2, X-FRNC & LSNH, 0,25mm³, 8 wires, twisted pairs)
 0342 = STL 342 (Fast Ethernet PROFINET C, shielded, green jacket, PUR, 4-wires, twisted pairs)
 0478 = STL 478 (Gigabit Ethernet Cat7, Industrial Cable, PUR, black jacket, 0,34mm³, 2x0,25mm³ for Data transmission, 2x0,34mm³, for powering)
 0182 = STL 182 (Standard Industrial Sensor/Actuator cable, shielded, PVC, orange jacket, 0,34mm³, 4 wires)
 0183 = STL 183 (Standard Industrial Sensor/Actuator cable, shielded, PVC, orange jacket, 0,34mm³, 5 wires)
 0288 = STL 288 (Standard Industrial Sensor/Actuator cable, shielded, PUR, black jacket, 0,34mm³, 4 wires)
 0298 = STL 298 (Standard Industrial Sensor/Actuator cable, shielded, PUR, black jacket, 0,34mm³, 5 wires)



Examples:
 Cordset (Double ended cable assembly):
 PP12M-MSSV4D-PP12M-MSSV4D-0342-0100
 Pigtail (Single ended cable assembly):
 PP12M-MSSV4D-0342-0100
 Field Attachable Crimp Termination:
 RM12C-MSSV4D

Benefits, Value, Competitor Advantage

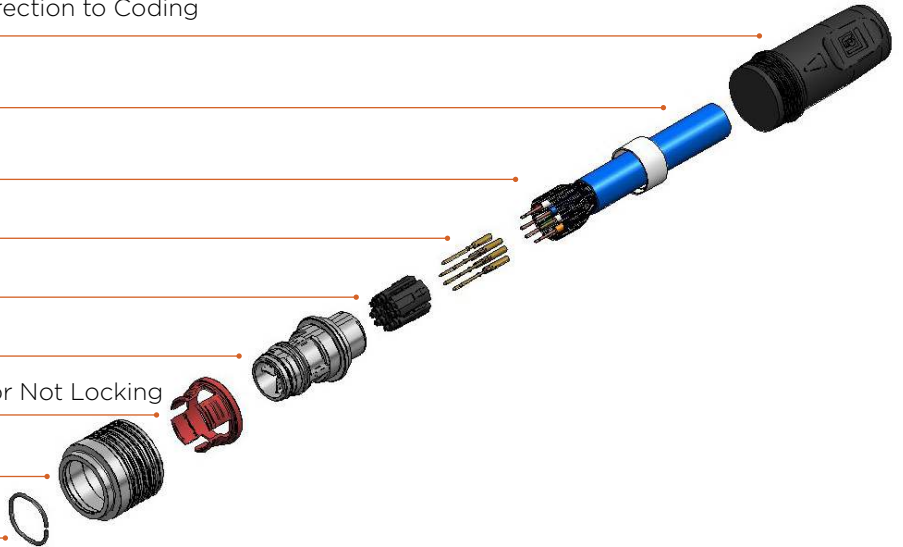
1. Overmolding Body with Integrated Direction to Coding
2. Braid Clamping
3. Cable, Stripped Jacket and Wires
4. Contacts
5. Contact Bearer
6. Connector Housing
7. Red Locking Hooks Indicate Locking or Not Locking
8. Release Sleeve
9. Shielding Overpass

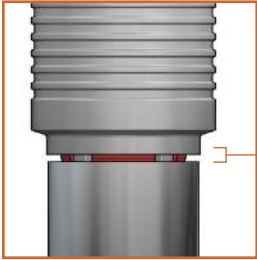

Why Belden

Competition	Belden Design	Your Value
		<p data-bbox="805 1098 1500 1312">The integrated arrow on the connector body indicates the coding direction. This feature allows you to connect Push Pull Cordsets correctly on the first try, eliminating the need for trial and error when finding the socket coding position on the device. This simplifies the installation process and saves time, ensuring quick and accurate connections.</p> <p data-bbox="805 1434 1500 1724">Belden has developed an innovative design specifically aimed at preventing dust, sweat particles, and coarse dirt from entering your devices. This protective collar is an effective preventive measure that not only significantly extends the lifespan of your equipment but also ensures its reliable functionality. By investing in the protection of your devices, you can reduce long-term operational costs and enhance your company's efficiency.</p>

The Future of Device Connection

After a long wait, the new M12 Push-Pull Standard IEC 61076-2-010 is finally being adopted across the connectivity industry, offering cross-manufacturer compatibility. This advancement promises to enhance efficiency and streamline operations in your business.









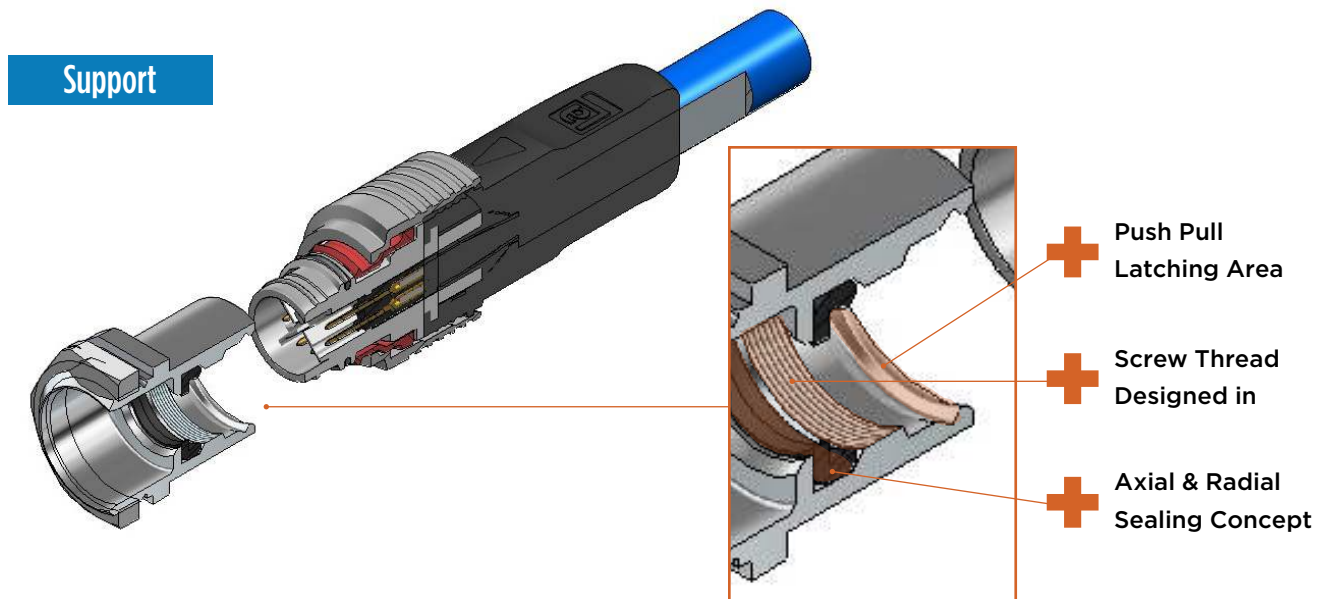



Is it possible to use push pull on your devices today?

The transition to Push Pull technology in accordance with IEC standards represents one of the most straightforward upgrades in industrial technology of such scale and significance to customers. One of the key advantages of this new Push-Pull technology is its backward compatibility. However, this assumes that your equipment already incorporates the necessary support of Push Pull.

To ensure a seamless and tailored solution that maximizes the benefits of this technology, we recommend reaching out to your Belden representative. They can provide expert guidance and [support](#) to ensure that your transition is smooth and that you fully leverage the advantages of the Push Pull technology.



M12 Push Pull Product Overview

	Side 1	Side 2		Product Description / Type 1M as Reference, Other Cable Lengths Available	Order No. Assembly	Solo Cable Type	Description
Sample Set				RPI2M-MSSV8X-RPI2R-Sample	935304201	74005PU	M12 Push Pull Sample Set of 10cm Pigtail & Receptacle housing incl. Sealing
Cordsets Double Ended			EN45545-2	RPI2M-MSSV4D-RPI2M-MSSV4D-0508-0100	935302005	BE43769	M12 cordset, Push Pull, Rolling Stock, EN45545, PUR black cable, shielded, male, straight, D-coded, 4-Pin, 4x0.34mm ² , PoE
				PPI2M-MSSV4D-PPI2M-MSSV4D-0342-0100	935302001	PROFINET Cables	M12 cordset, Push Pull, similar PROFINET Type C, PUR green cable, shielded, male, straight, D-coded, 4-Pin, 2x2x0.34mm ² , star-quad, PoE
		RJ45	Coming Soon	RPI2M-MSSV4D-RJ45I-MSSV4E-0342-0100	On Request	PROFINET Cables	M12 cordset, Push Pull, Rolling Stock, EN45545, PUR black cable, shielded, male, straight, D-coded to RJ45, 4-Pin, 4x0.34mm ² , PoE
Pigtails Single Ended		Pigtail, No Side 2 Connected	EN45545-2	RPI2M-MSSV4D-0508-0100	935301025	BE43769	M12 pigtail, Push Pull, Rolling Stock, EN45545, PUR black cable, shielded, male, straight, D-coded, 4-Pin, 4x0.34mm ² , PoE
				PPI2M-MSSV4D-0342-0100	935301021	PROFINET Cables	M12 pigtail, Push Pull, similar PROFINET Type C, PUR green cable, shielded, male, straight, D-coded, 4-Pin, 2x2x0.34mm ² , star-quad, PoE
Cordsets Double Ended			EN45545-2	RPI2M-MSSV8X-RPI2M-MSSV8X-0552-0100	935300405	BE43802	M12 cordset, Push Pull, Rolling Stock, CAT 7, EN45545, X-FRNC/LSNH blue cable, shielded, male, straight, X-coded, 8-Pin, 4x2x0.25mm ² , twisted pairs, PoE+
				PPI2M-MSSV8X-PPI2M-MSSV8X-0478-0100	935300401	74005PU	M12 cordset, Push Pull, Industrial CAT 7, PUR black cable, shielded, male, straight, X-coded, 8-Pin, 4x2x0.14mm ² , twisted pairs, PoE+
		RJ45	Coming Soon	RPI2M-MSSV8X-RJ45I-MSSV8G-0478-0100	On Request	74005PU	M12 cordset, Push Pull, PUR black cable, shielded, male, straight, X-coded to RJ45, 8-Pin, 8x2x0.14mm ² , PoE
Pigtails Single Ended	X-Code	Pigtail, No Side 2 Connected	EN45545-2	RPI2M-MSSV8X-0552-0100	935300005	BE43802	M12 pigtail, Push Pull, Rolling Stock, CAT 7, EN45545, X-FRNC/LSNH blue cable, shielded, male, straight, X-coded, 8-Pin, 4x2x0.25mm ² , twisted pairs, PoE+
				PPI2M-MSSV8X-0478-0100	935300001	74005PU	M12 pigtail, Push Pull, Industrial CAT 7, PUR black cable, shielded, male, straight, X-coded, 8-Pin, 4x2x0.14mm ² , twisted pairs, PoE+
				PP12R-FSSV8X-0478-0100 Female Flange	On Request	74005PU	M12 pigtail, Push Pull Integration, Industrial CAT 5, rear mounting flange, PUR black cable, shielded, female, straight, X-coded, 8-Pin, 4x2x0.14mm ² , twisted pairs, PoE+
Pigtails Single Ended		Pigtail, No Side 2 Connected		PPI2M-MSSV4A-0288-0100	935301001	934636452 - STL 288/100 M PUR 934636453 - STL 288/500 M PUR	M12 pigtail, Push Pull, industrial sensor cable, PUR black cable, shielded, male, straight, A-coded, 4-Pin, 4x0.34mm ²
				PPI2M-MSSV4A-0182-0100	935301005	3399 - STL 182/100 M PVC	M12 pigtail, Push Pull, industrial sensor cable, PVC orange cable, shielded, male, straight, A-coded, 4-Pin, 4x0.34mm ²
		Pigtail, No Side 2 Connected		PPI2M-MSSV5A-0183-0100	935301013	On Request	M12 pigtail, Push Pull, industrial sensor cable, PVC orange cable, shielded, male, straight, A-coded, 5-Pin, 5x0.34mm ²
				PPI2M-MSSV5A-0298-0100	935301009	934637347 - STL 298/100 M PUR 934637111 - STL 298/500 M PUR	M12 pigtail, Push Pull, industrial sensor cable, PUR black cable, shielded, male, straight, A-coded, 5-Pin, 4x0.34mm ²
Receptacle Housing for front Wall Mounting			RPI2R-PushPull-Sample	935304001		M12 Push Pull Integration, receptacle housing	
Hirschmann BXP Switches with integrated Push Pull Logic			BXP62-28TX-EECC-HV-3A	942334004		<p>"The Hirschmann BXP (BOBCAT eXtreme Performance) managed switch offers a compact design, enhanced flexibility and interoperability, and speeds of up to 10 Gbps for railway rolling stock applications.</p> <ul style="list-style-type: none"> + Power over Ethernet (PoE++) with up to 120 W + High port density, including 20-port and 28-port variants + Robust bandwidth and speed capabilities with up to 6x 10 Gigabit Ethernet" 	

Related Products Data Communication

Coding	Connector Version	Belden/Lumberg Reference	Construction	Outer Cable Diameter	Wire Cross Section
X-Coding	Female Straight	0986 EMC 600	M12 Connector, IDC Termination , Rolling Stock, Straight, Female, 8-Pin, X-coded, incl. Pins	Ø5...Ø9,7 mm	0,14mm ² - 0,34 mm ² (AWG 26 - 22)
D-Coding	Male Straight	BRSCIS 4D/9	M12 Connector, IDC Termination , Rolling Stock, Straight, Male, 4-Pin, D-coded, incl. Pins	Ø6...Ø8 mm	0,20 mm ² ...0,34 mm ² (AWG 24 - 22)
D-Coding	Male Straight	0986 EMC 105	M12 Connector, Spring-Type Termination , Rolling Stock, Straight, Male, 4-Pin, D-coded, incl. Pins	Ø6,7 mm	0,14mm ² - 0,5 mm ² (AWG 26 - 20)
	Female Straight	0986 EFC 107	M12 Connector, Spring-Type Termination , Rolling Stock, Straight, Female, 4-Pin, D-coded, incl. Pins	Ø6,7 mm	"0,14mm ² - 0,5 mm ² (with wire end ferrule) (AWG 26 - 20)"
D-Coding	Male Straight	RM12C-MSSV4D-CAT5	M12 Connector, Crimp Termination , Rolling Stock, Straight, Male, 4-Pin, D-coded, incl. Pins	Ø6,0...Ø8,5 mm	0,34mm ² ...0,5 mm ² (AWG 22 - 20)
	Male Angled	RM12C-MASV4D-CAT5	M12 Connector, Crimp Termination , Rolling Stock, Angled, Male, 4-Pin, D-coded, incl. Pins	Ø6,0...Ø8,5 mm	0,34mm ² ...0,5 mm ² (AWG 22 - 20)
	Female Straight	RM12C-FSSV4D-CAT5	M12 Connector, Crimp Termination , Rolling Stock, Straight, Female, 4-Pin, D-coded, incl. Pins	Ø6,0...Ø8,5 mm	0,34mm ² ...0,5 mm ² (AWG 22 - 20)
	Female Straight Rear Mount	RM12C-FSSR4D-CAT5	M12 Connector, Crimp Termination , Rolling Stock, Straight, Female, 4-Pin, D-coded, Back Mounting, incl. Pins	Ø6,0...Ø8,5 mm	0,34mm ² ...0,5 mm ² (AWG 22 - 20)
	Female Angled	RM12C-FASV4D-CAT5	M12 Connector, Crimp Termination , Rolling Stock, Angled, Female, 4-Pin, D-coded, incl. Pins	Ø6,0...Ø8,5 mm	0,34mm ² ...0,5 mm ² (AWG 22 - 20)
X-Coding	Male Straight	RM12C-MSSV8X-CAT6a	M12 Connector, Crimp Termination , Rolling Stock, Straight, Male, 8-Pin, X-coded, incl. Pins	Ø6,0...Ø8,5 mm	0,14mm ² ...0,2 mm ² (AWG 26 - 24)
A-Coding	Male Straight	RM12C-MSSV4A	M12 Connector, Crimp Termination , Rolling Stock, Straight, Male, 4-Pin, A-coded, incl. Pins	Ø5,0...Ø8,5 mm	0,34mm ² ...0,75 mm ² (AWG 22-18)
		RM12C-MSSV5A	M12 Connector, Crimp Termination , Rolling Stock, Straight, Male, 5-Pin, A-coded, incl. Pins	Ø6,0...Ø8,5 mm	0,34mm ² ...0,75 mm ² (AWG 22-18)
		RM12C-MSSV8A	M12 Connector, Crimp Termination , Rolling Stock, Straight, Male, 8-Pin, A-coded, incl. Pins	Ø6,0...Ø8,5 mm	0,20 mm ² ...0,34 mm ² (AWG 24 - 22)
	Male Angled	RM12C-MASV4A	M12 Connector, Crimp Termination , Rolling Stock, Angled, Male, 4-Pin, A-coded, incl. Pins	Ø6,0...Ø8,5 mm	0,34mm ² ...0,75 mm ² (AWG 22-18)
		RM12C-MASV5A	M12 Connector, Crimp Termination , Rolling Stock, Angled, Male, 5-Pin, A-coded, incl. Pins	Ø6,0...Ø8,5 mm	0,34mm ² ...0,75 mm ² (AWG 22-18)
		RM12C-MASV8A	M12 Connector, Crimp Termination , Rolling Stock, Angled, Male, 8-Pin, A-coded, incl. Pins	Ø6,0...Ø8,5 mm	0,20 mm ² ...0,34 mm ² (AWG 24 - 22)
	Female Straight	RM12C-FSSV4A	M12 Connector, Crimp Termination , Rolling Stock, Straight, Female, 4-Pin, A-coded, incl. Pins	Ø6,0...Ø8,5 mm	0,34mm ² ...0,75 mm ² (AWG 22-18)
		RM12C-FSSV5A	M12 Connector, Crimp Termination , Rolling Stock, Straight, Female, 5-Pin, A-coded, incl. Pins	Ø6,0...Ø8,5 mm	0,34mm ² ...0,75 mm ² (AWG 22-18)
	Female Angled	RM12C-FASV4A	M12 Connector, Crimp Termination , Rolling Stock, Angled, Female, 4-Pin, A-coded, incl. Pins	Ø6,0...Ø8,5 mm	0,34mm ² ...0,75 mm ² (AWG 22-18)
		RM12C-FASV5A	M12 Connector, Crimp Termination , Rolling Stock, Angled, Female, 5-Pin, A-coded, incl. Pins	Ø6,0...Ø8,5 mm	0,34mm ² ...0,75 mm ² (AWG 22-18)
N/A		XZC 0708 RM12	RM12C Crimping Tool DMC, Incl. Locator	N/A	N/A